



安徽理工大学

混合量子系统中光传输的量子调控

陈华俊

安徽理工大学 力学与光电物理学院

一、背景介绍

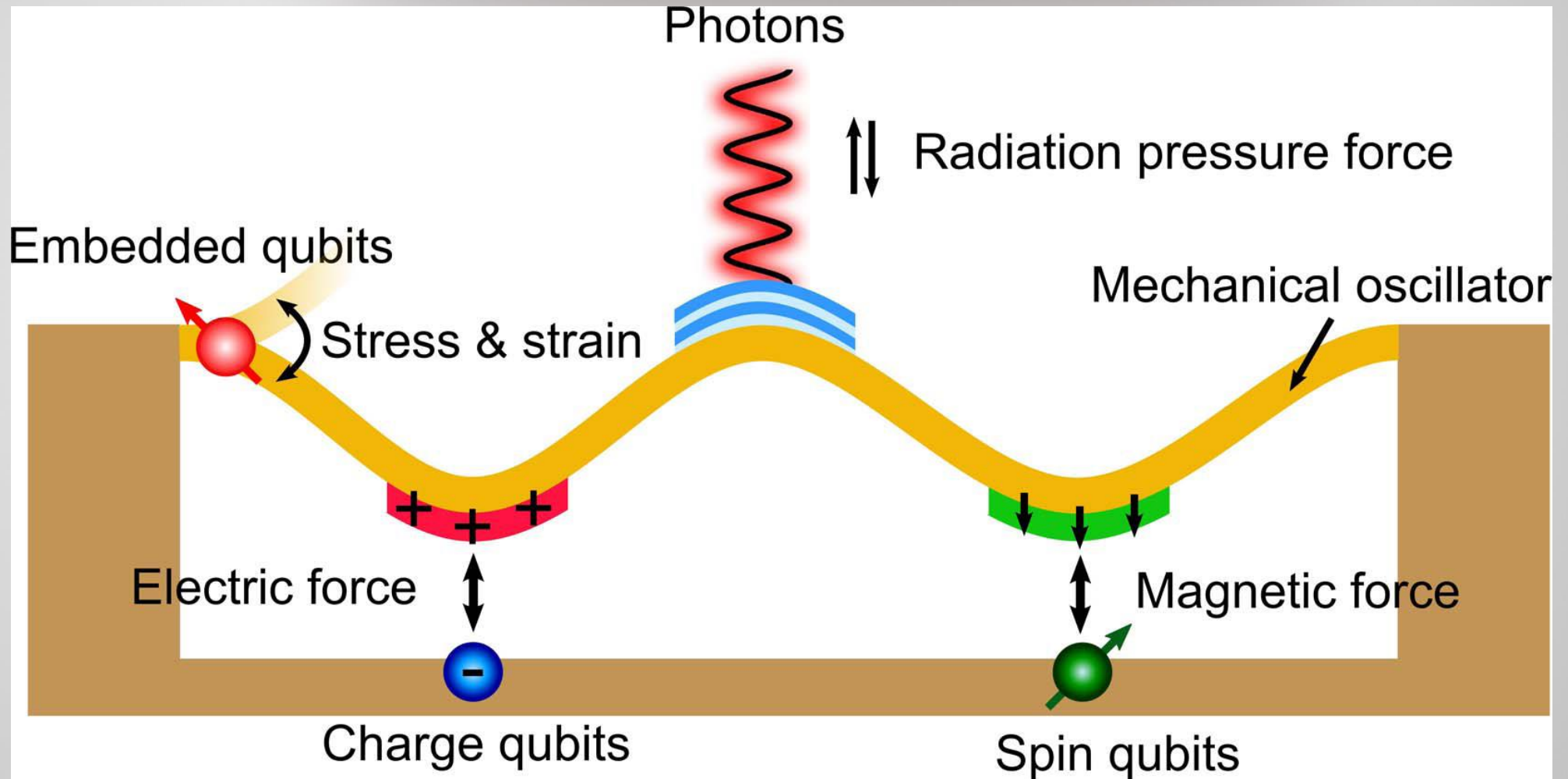

一、背景介绍

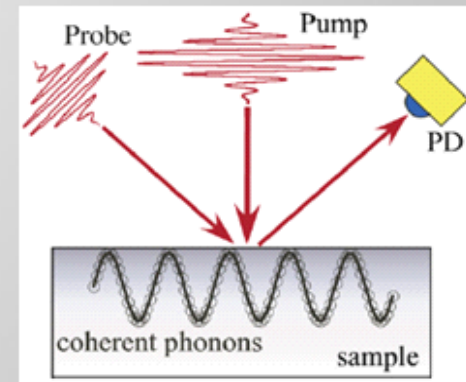
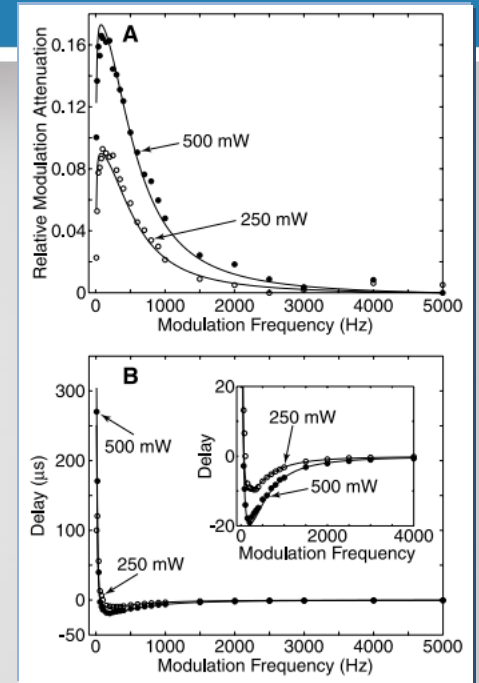
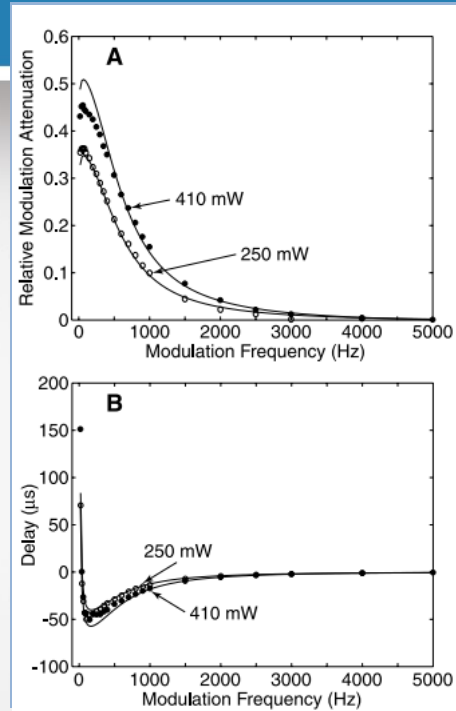
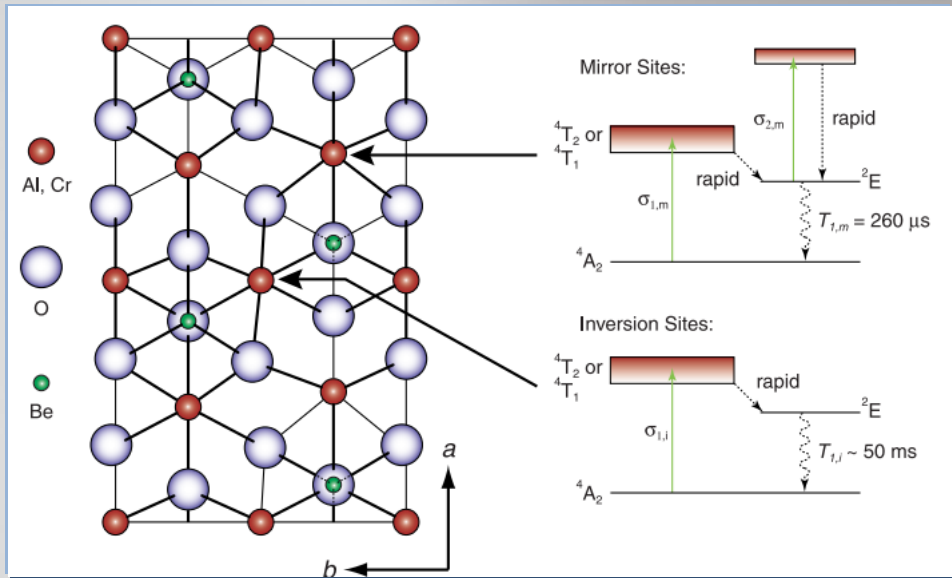

Bigelow, M. S., Lepeshkin, N. N., & Boyd, R. W. (2003). Superluminal and slow light propagation in a room-temperature solid. *Science*, 301(5630), 200-202. 翠绿宝石晶体

Group velocity v_g

$v_g < c$ 慢光

$v_g > c$ 快光

$$v_g = \frac{c}{n_g}$$

$$n_g = n + \omega_s \frac{dn}{d\omega_s}$$



$$v_g = \frac{c}{n + \omega_s (dn/d\omega_s)}$$

慢光产生机制：电磁诱导透明、相干布居数振荡、受激布里渊散射、声子诱导透明

Boyd, R. W., & Gauthier, D. J. (2009). Controlling the velocity of light pulses. *science*, 326(5956), 1074-1077.

二、混合量子系统

Strain Coupling of a Mechanical Resonator to a Single Quantum Emitter

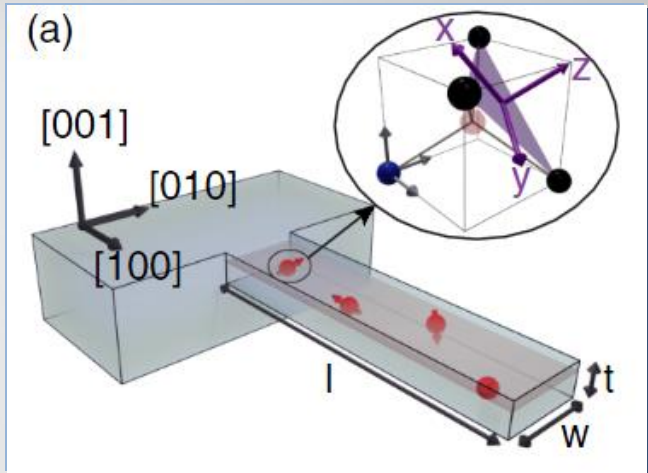
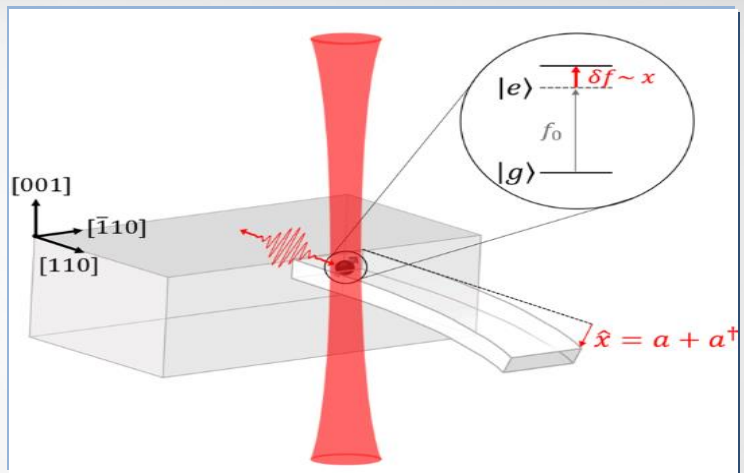
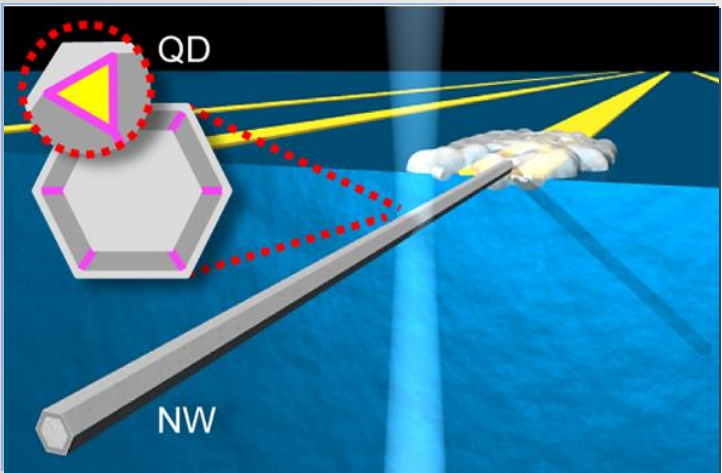

Montinaro, M. et al. Nano letters 14.8 (2014): 4454-4460.

Lee, Kenneth W., et al Physical Review Applied 6 (2016): 034005.

Teissier, J., et al. Physical review letters 113.2 (2014): 020503.

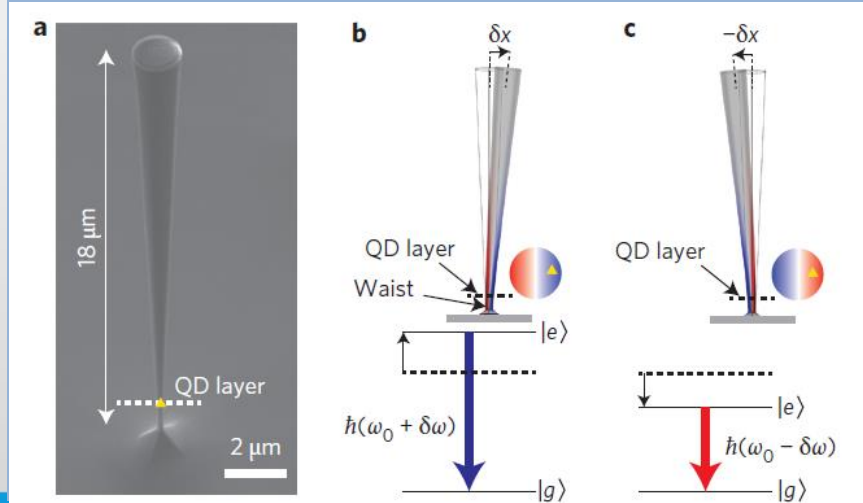
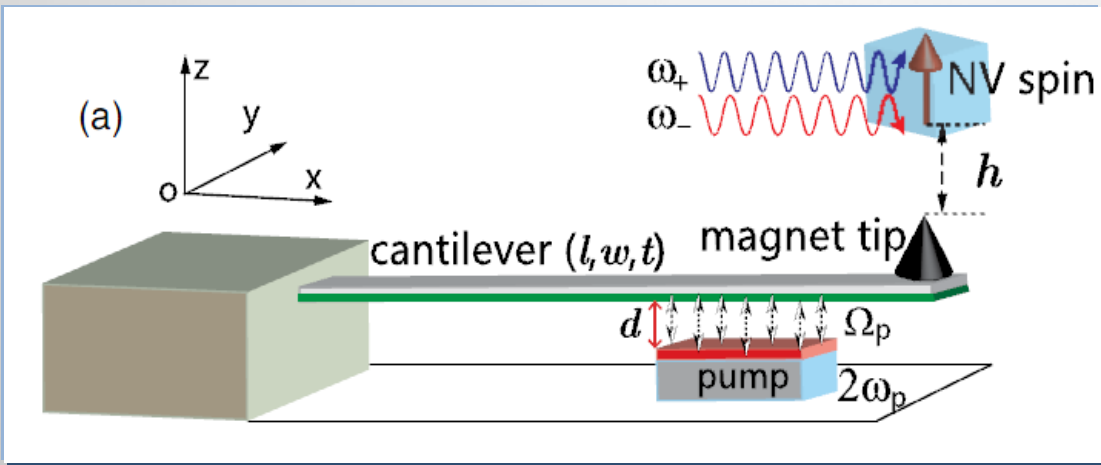

Li, Peng-Bo, et al. "Enhancing spin-phonon and spin-spin interactions using linear resources in a hybrid quantum system." Physical Review Letters 125.15 (2020): 153602.

Yeo, Inah, et al. "Strain-mediated coupling in a quantum dot-mechanical oscillator hybrid system." Nature nanotechnology 9.2 (2014): 106-110.

Mechanical mode coupling

(a) Piezoelectric effect

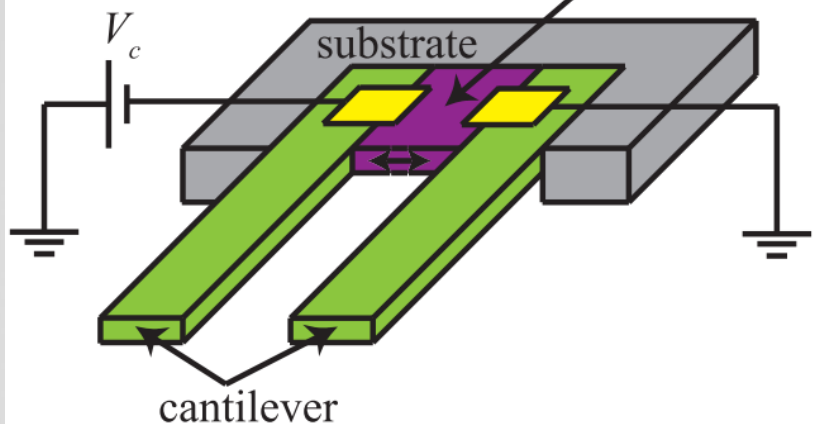

(b) Photothermal effect

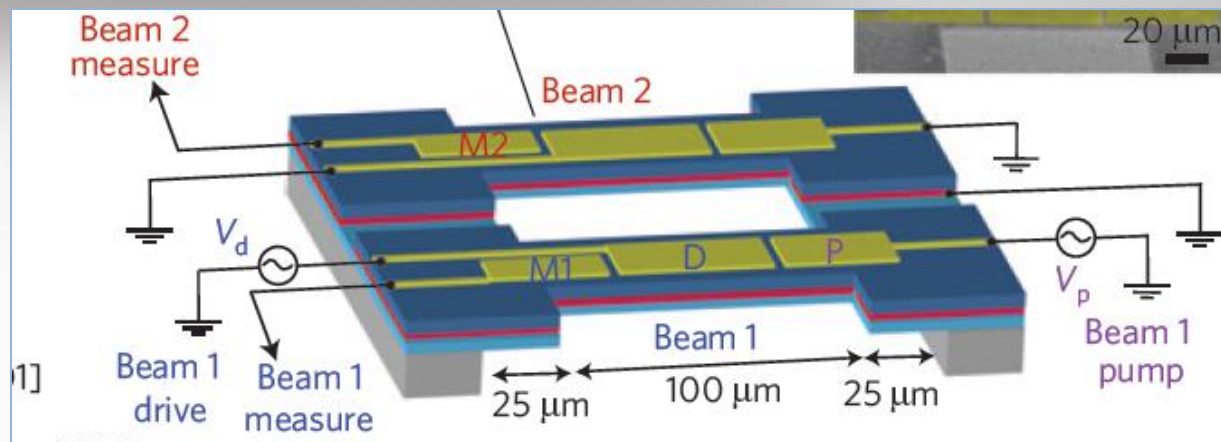
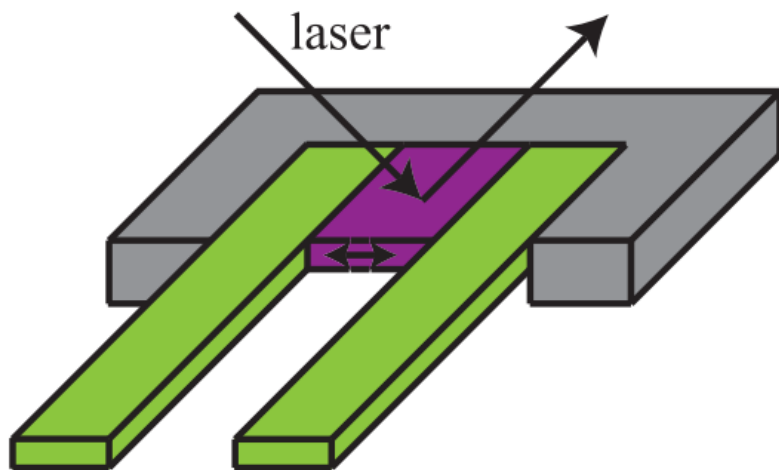

Okamoto, Hajime, et al. "Coherent phonon manipulation in coupled mechanical resonators." *Nature Physics* 9.8 (2013): 480-484.

In addition, the two vibrating mirrors can also be coupled through the **electrostatic force** or **Coulomb interaction** for charged vibrating mirrors.

三、我的工作：复合纳米机械振子系统中的光学现象

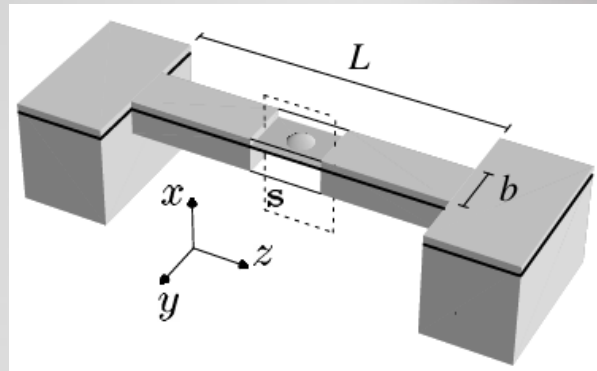

Wilson-Rae I, Zoller P, Imamoglu A. Laser cooling of a nanomechanical resonator mode to its quantum ground state[J]. Physical review letters, 2004, 92(7): 075507.

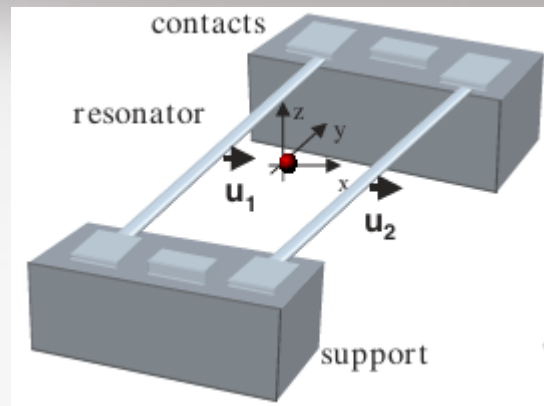

Tian L, Zoller P. Coupled ion-nanomechanical systems[J]. Physical review letters, 2004, 93(26): 266403.

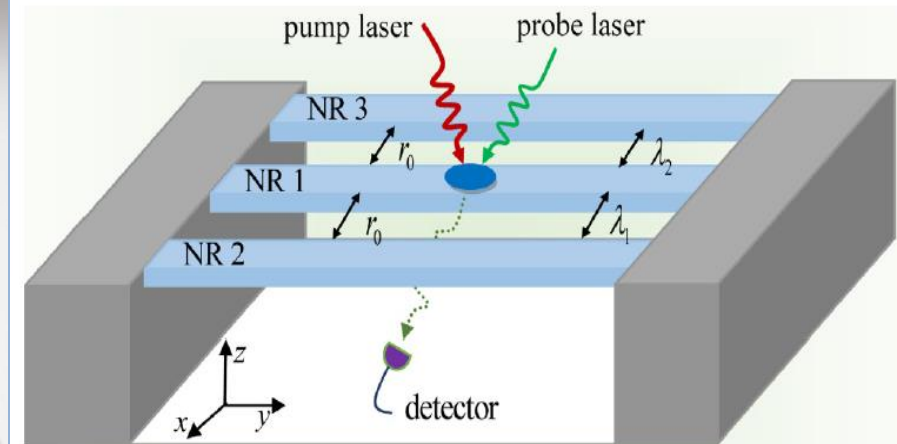

$$\begin{aligned}
 H = & \hbar\omega_{ex}S^z + \hbar\omega_{m1}a_1^\dagger a_1 + \hbar\omega_{m2}a_2^\dagger a_2 + \hbar\omega_{m3}a_3^\dagger a_3 \\
 & + \hbar\omega_{m1}\beta S^z(a_1^\dagger + a_1) + \hbar\lambda_1(a_1^\dagger a_2 + a_1 a_2^\dagger) \\
 & + \hbar\lambda_2(a_1^\dagger a_3 + a_1 a_3^\dagger) - \mu\varepsilon_p(S^\dagger e^{-i\omega_p t} + S^- e^{i\omega_p t}) \\
 & - \mu\varepsilon_s(S^\dagger e^{-i\omega_s t} + S^- e^{i\omega_s t}),
 \end{aligned}$$

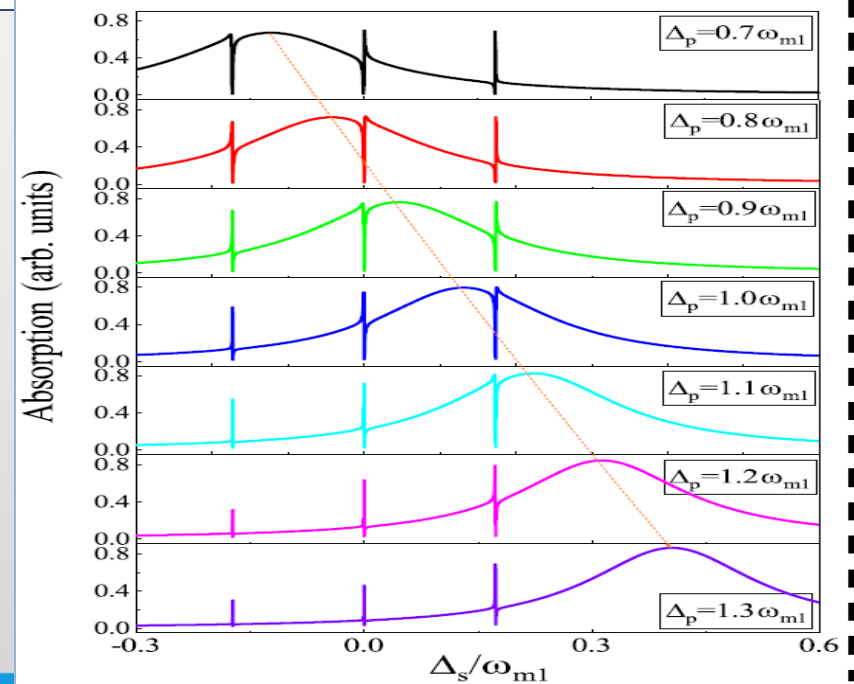

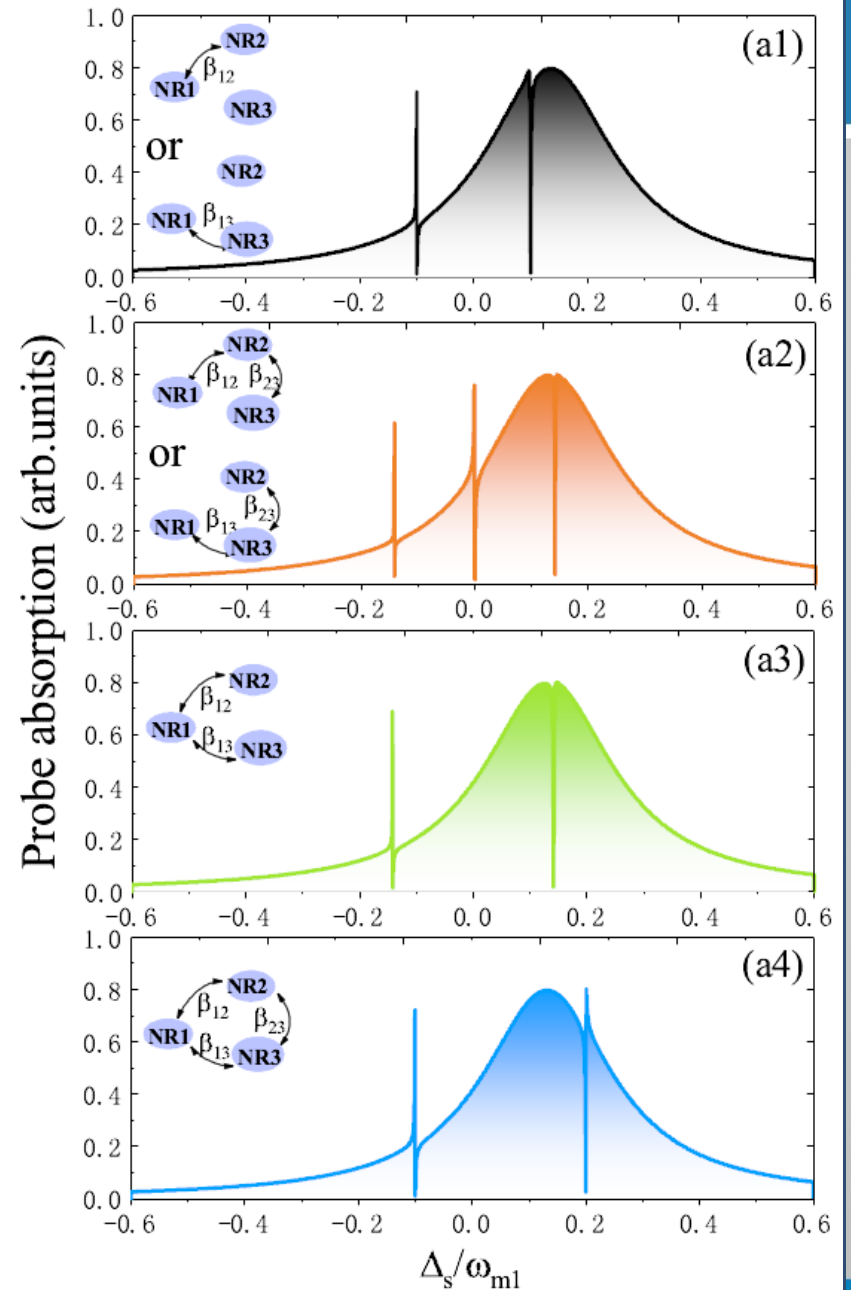
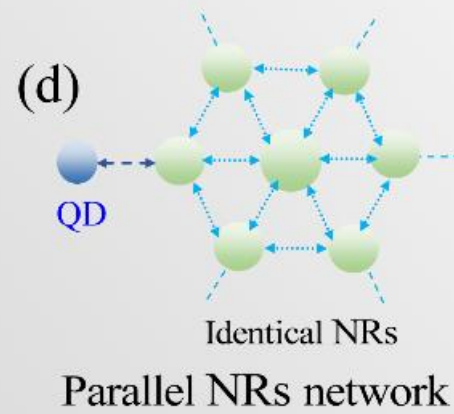
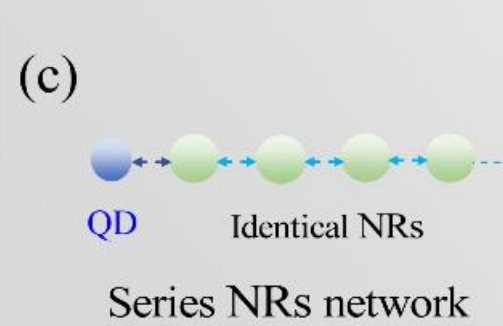
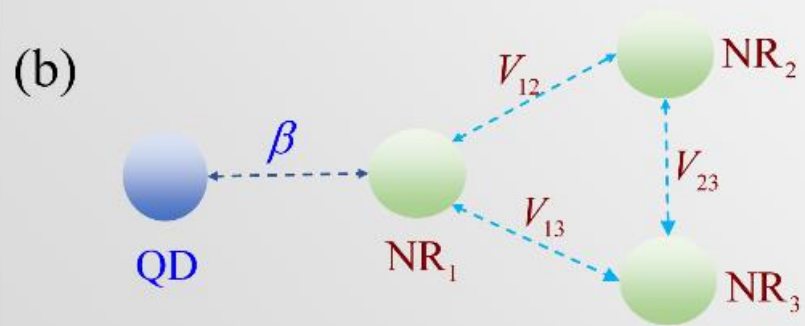
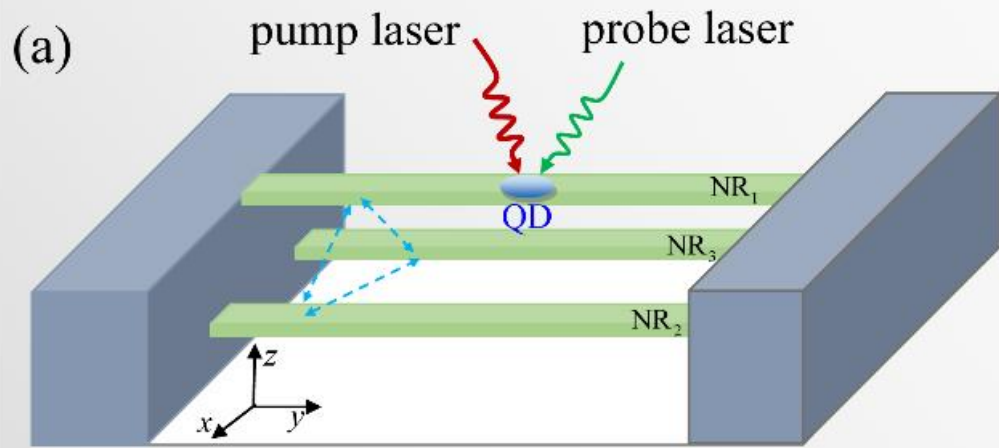

金刚石空位自旋-机械振子系统(强耦合)

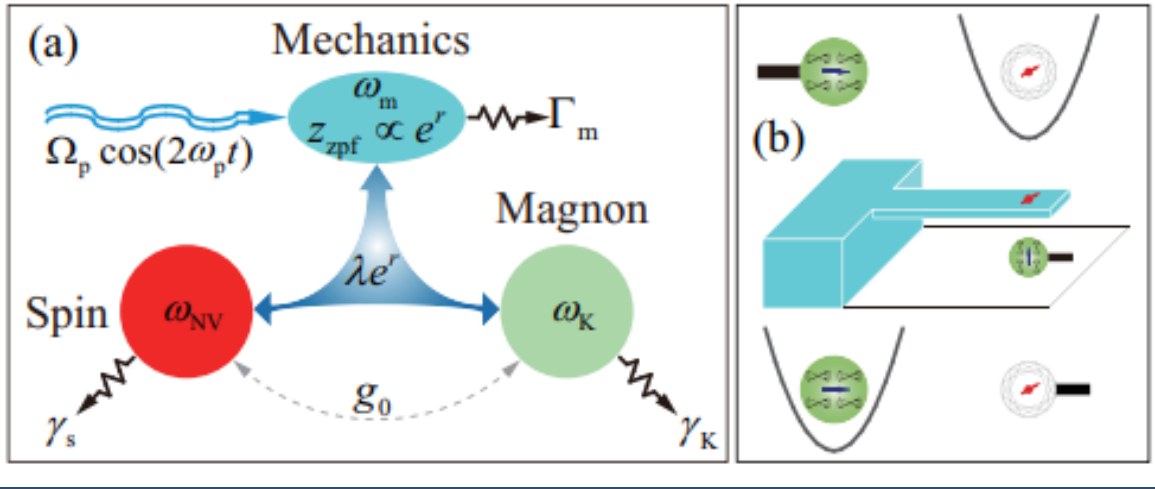
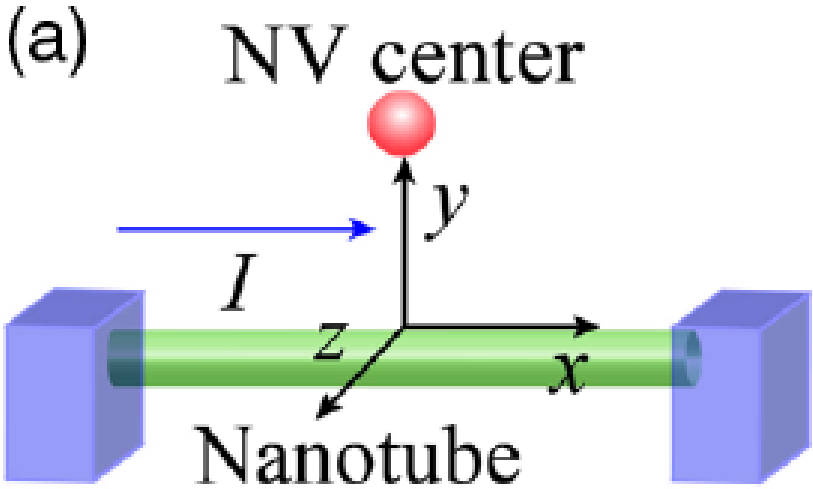

Li, Peng-Bo, et al. "Hybrid quantum device with nitrogen-vacancy centers in diamond coupled to carbon nanotubes." Physical review letters 117.1 (2016): 015502.

Hei X L, Li P B, Pan X F, et al. Enhanced tripartite interactions in spin-magnon-mechanical hybrid systems. Physical Review Letters, 2023, 130(7): 073602.

The coupling of NV spins between mechanical resonators can be achieved extrinsically (external **magnetic field gradients**) or intrinsically (mechanical strain).

NV自旋：即使在室温下，相干时间也很长
 碳纳米管振子：超低质量，超高和广泛可调的频率，以及超高Q因子

双色电磁诱导透明现象

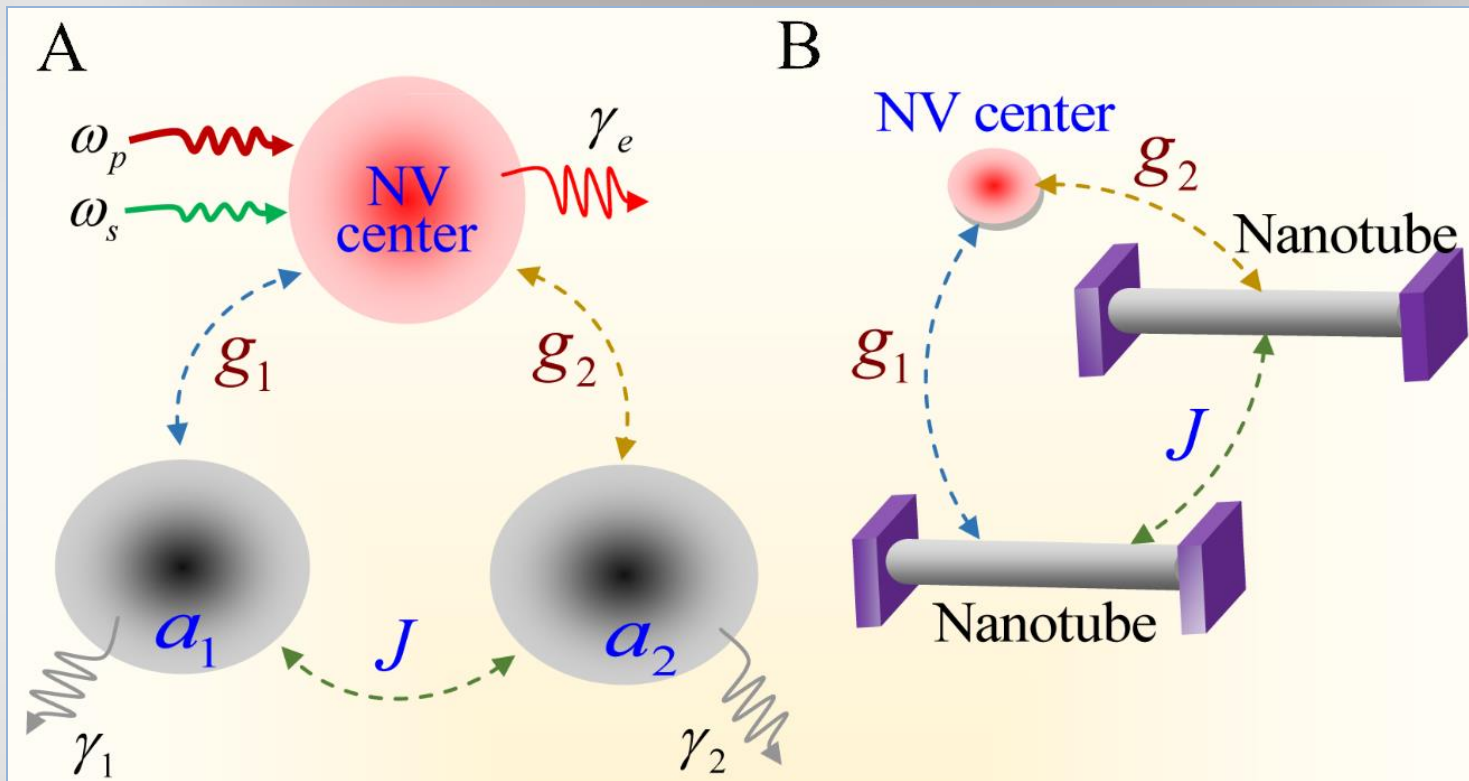

$$\begin{aligned}
 H &= H_{CNT} + H_{NV} + H_{S-R} + H_{int} + H_{dri} \\
 &= \sum_{k=1,2} \hbar\omega_k a_k^\dagger a_k + \frac{1}{2} \hbar\Delta_p \sigma^z + \sum_{k=1,2} \hbar g_k (a_k^\dagger \sigma^- + a_k \sigma^+) + \hbar J (e^{i\theta} a_1^\dagger a_2 + e^{-i\theta} a_1 a_2^\dagger) \\
 &\quad - \hbar\Omega_p (\sigma^+ + \sigma^-) - \mu\epsilon_s (\sigma^+ e^{-i\delta t} + \sigma^- e^{i\delta t}),
 \end{aligned}$$

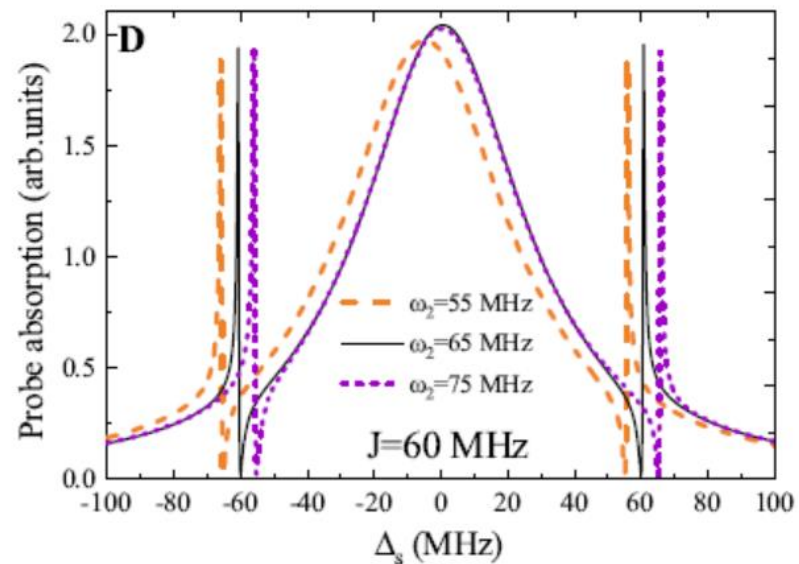
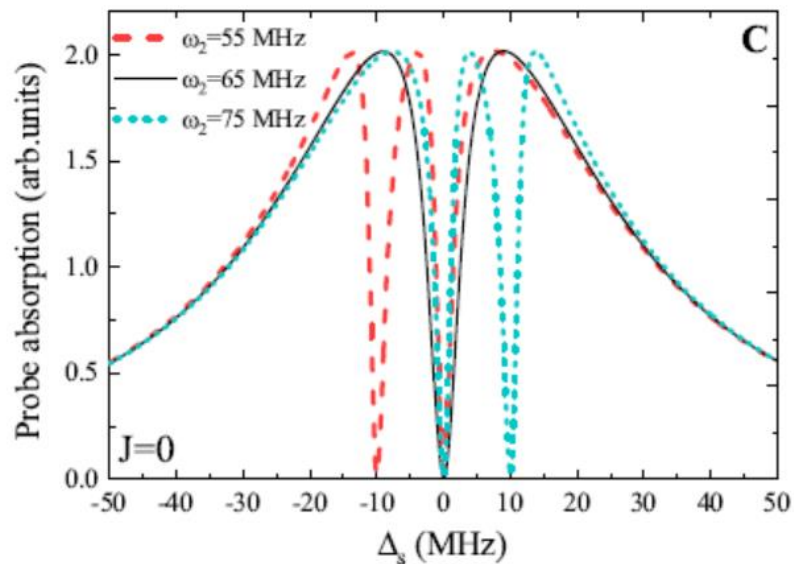
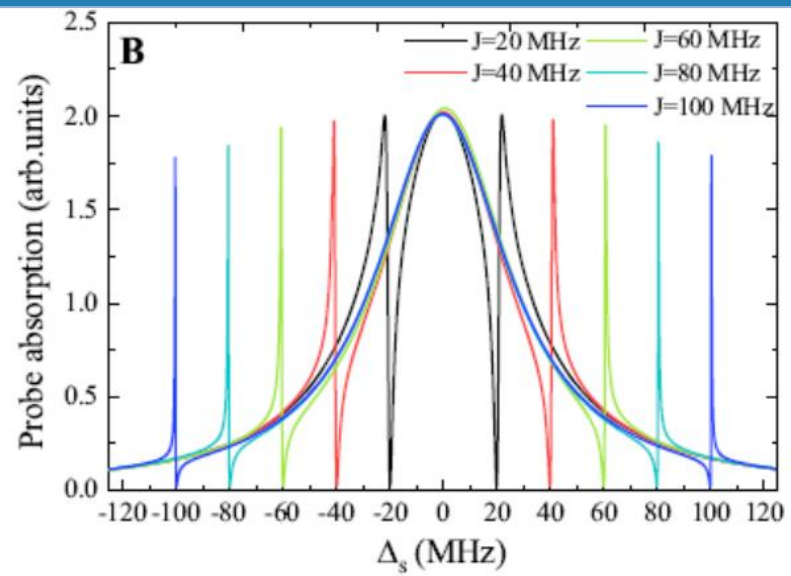
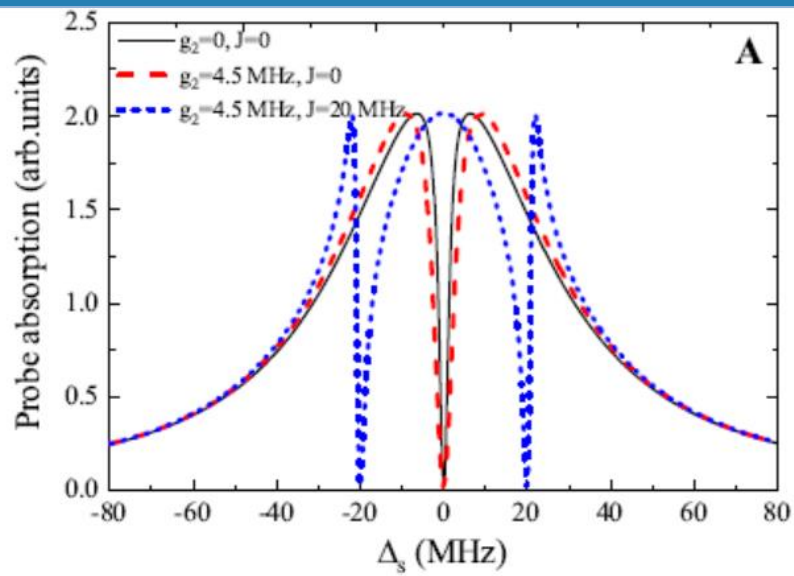

In the condition of the strong-driving regime, i.e., the pump field is more stronger than the probe field, according to the linearized Langevin equations of Equation 9 to Equation 11, the Hamiltonian in the rotating-wave approximation [16, 17] is ($\hbar = 1$)

$$H_{RWA} = \frac{1}{2}\Delta_p\delta\sigma^z + \omega_1\delta a_1^\dagger\delta a_1 + \omega_2\delta a_2^\dagger\delta a_2 + g_1(\delta a_1^\dagger\delta\sigma^- + \delta a_1\delta\sigma^+) + g_2(\delta a_2^\dagger\delta\sigma^- + \delta a_2\delta\sigma^+) + J(e^{i\theta}\delta a_1^\dagger\delta a_2 + e^{-i\theta}\delta a_1\delta a_2^\dagger). \quad (16)$$

In order to investigate the role of phonon-exchange interaction, two bosonic modes \bar{A}_+ and \bar{A}_- are introduced as following

$$\bar{A}_+ = f\delta a_1 - e^{i\theta}h\delta a_2, \quad \bar{A}_- = e^{-i\theta}h\delta a_1 + f\delta a_2, \quad (17)$$

then, the Hamiltonian of Equation 16 reduces to

$$H_{RWA} = \frac{1}{2}\Delta_p\delta\sigma^z + \bar{\omega}_+\bar{A}_+^\dagger\bar{A}_+ + \bar{\omega}_-\bar{A}_-^\dagger\bar{A}_- + \bar{g}_+(\delta\sigma^-\bar{A}_+^\dagger + \bar{A}_+\delta\sigma^+) + \bar{g}_-(\delta\sigma^-\bar{A}_-^\dagger + \bar{A}_-\delta\sigma^+), \quad (18)$$

where resonance frequencies and coupling strengths are as follows

$$\bar{\omega}_\pm = \frac{1}{2}(\omega_1 + \omega_2) \pm \sqrt{(\omega_1 - \omega_2)^2 + 4J^2}, \quad (19)$$

$$\bar{g}_+ = fg_1 - e^{i\theta}hg_2, \quad \bar{g}_- = e^{-i\theta}hg_1 + fg_2, \quad (20)$$

with the two parameters of

$$f = \frac{|\bar{\omega}_- - \omega_1|}{\sqrt{(\bar{\omega}_- - \omega_1)^2 + J^2}}, \quad h = \frac{Jf}{\bar{\omega}_- - \omega_1}. \quad (21)$$

When the two mechanical modes have the same frequencies, $\omega_1 = \omega_2$, and coupling strengths, $g_1 = g_2 = g$, the coupling strengths in Equation 20 can be simplified as

$$\bar{g}_+ = \frac{\sqrt{2}g(1 + e^{-i\theta})}{2}, \quad \bar{g}_- = \frac{\sqrt{2}g(1 - e^{-i\theta})}{2}. \quad (22)$$

In Equation 22, when $\theta = n\pi$ for an integer n , the spin mode is decoupled from one of the two hybridized mechanical modes \bar{A}_- (for an even number n) and \bar{A}_+ (for an odd number n). These features mean that the dark-mode effect can be broken by tuning the modulation phase $\theta \neq n\pi$.

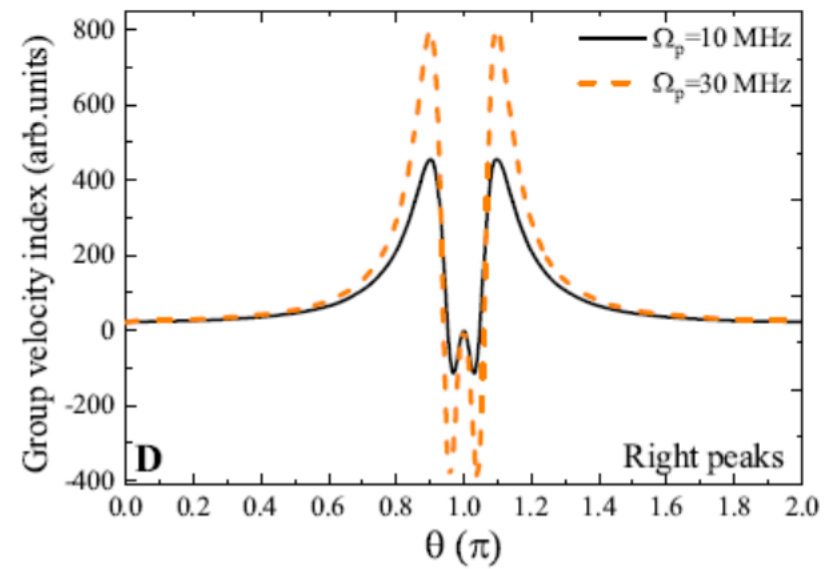
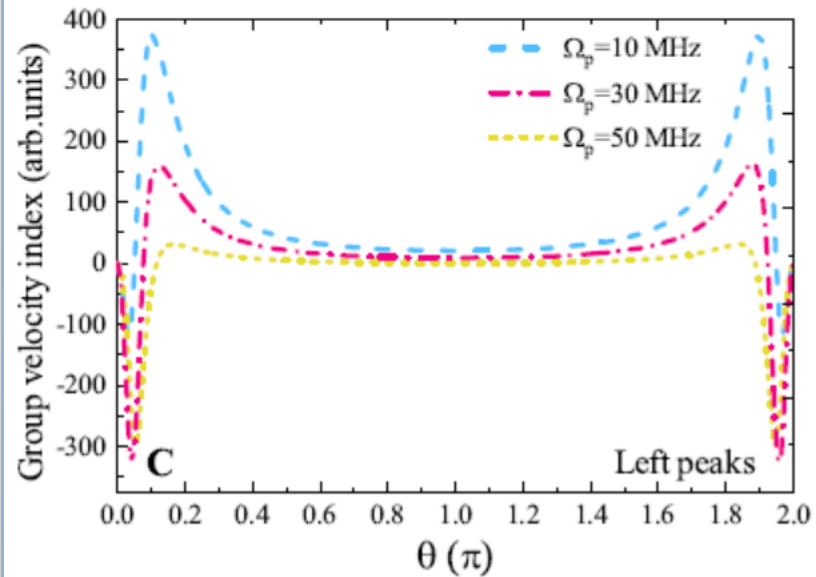
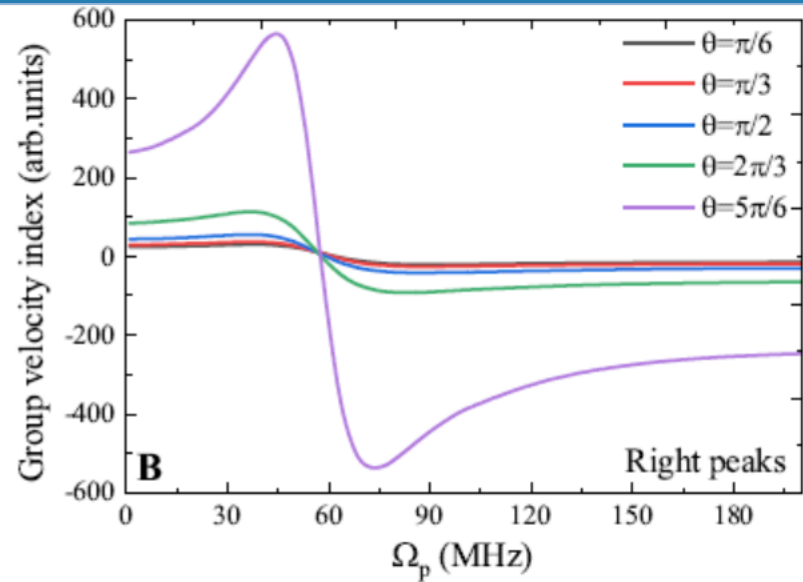
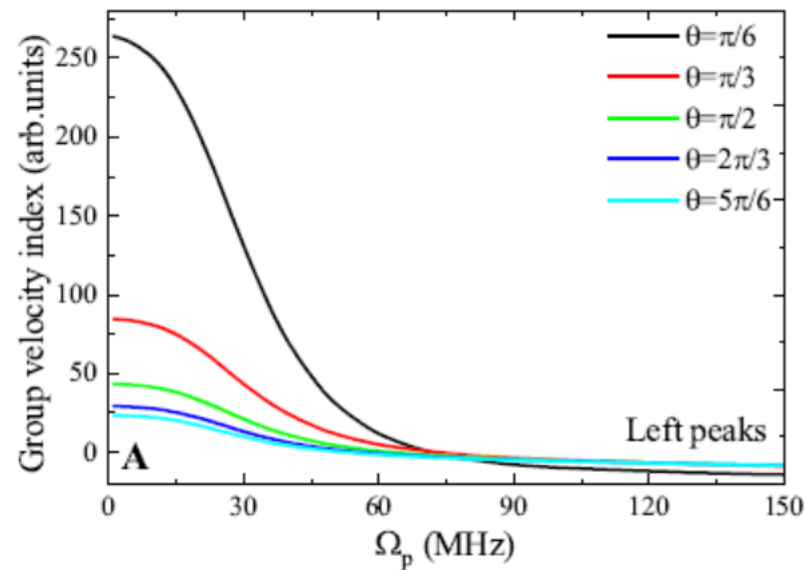

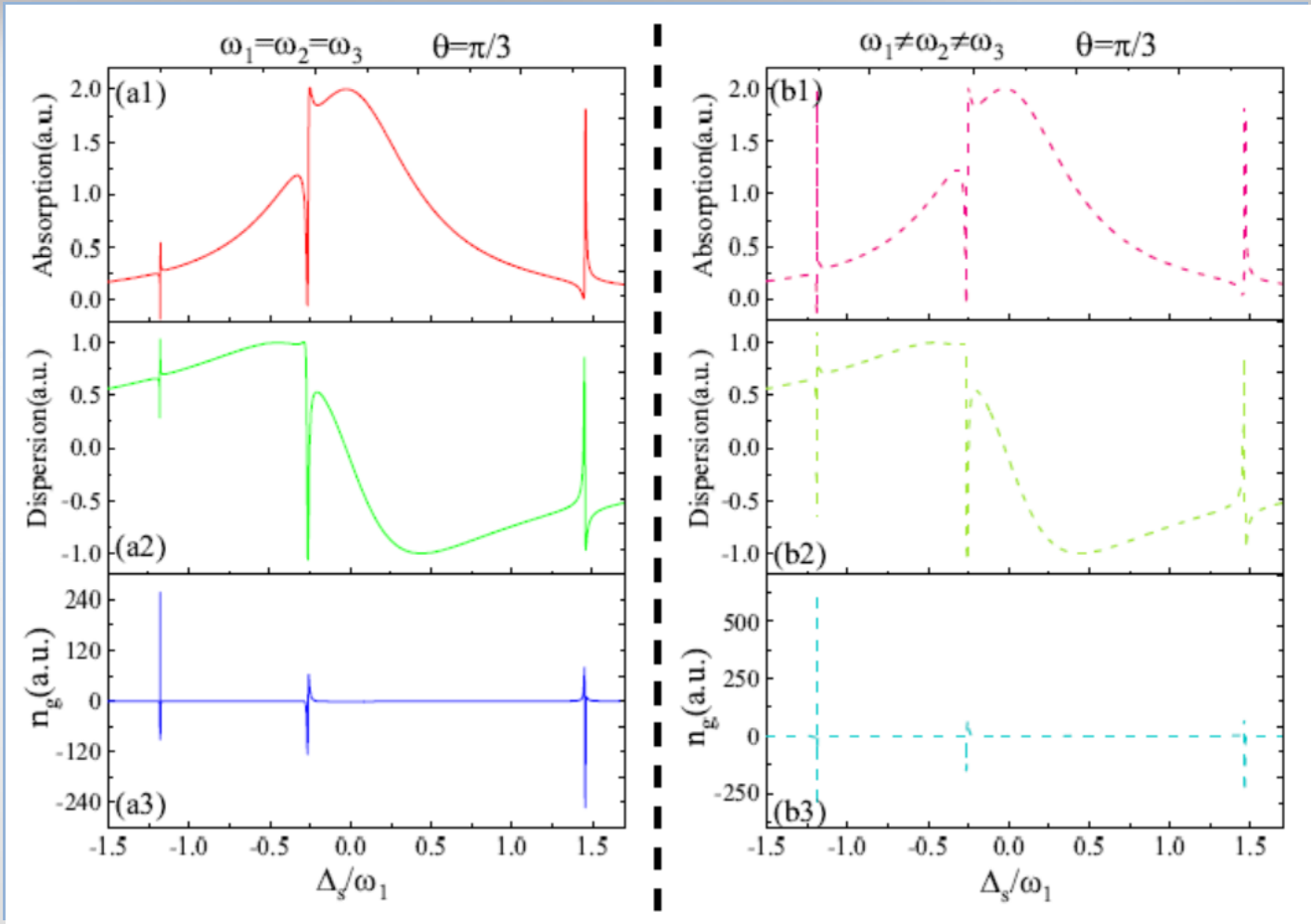
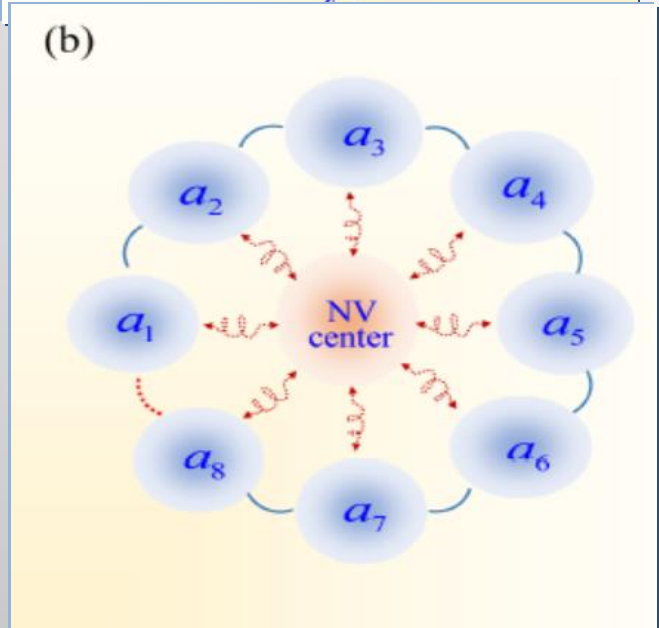
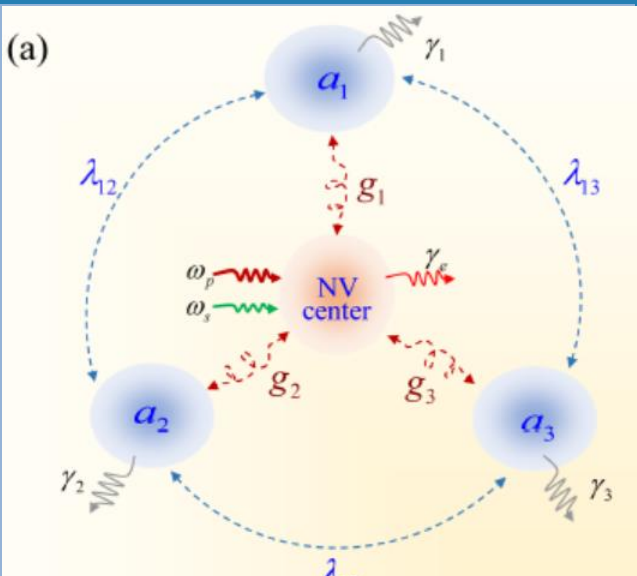

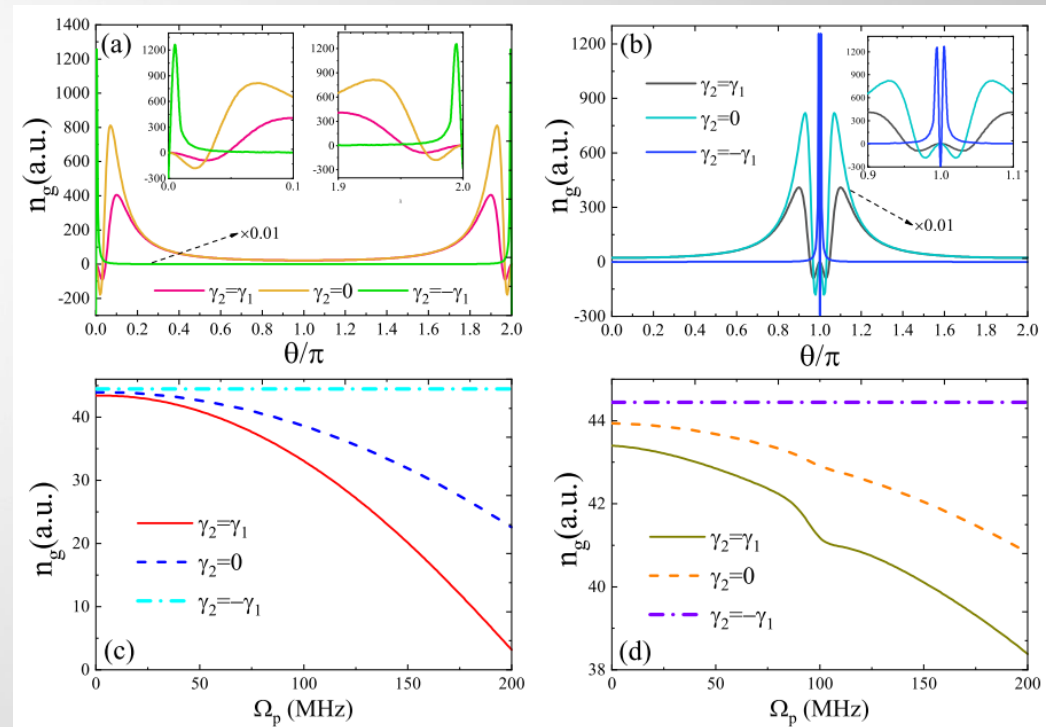
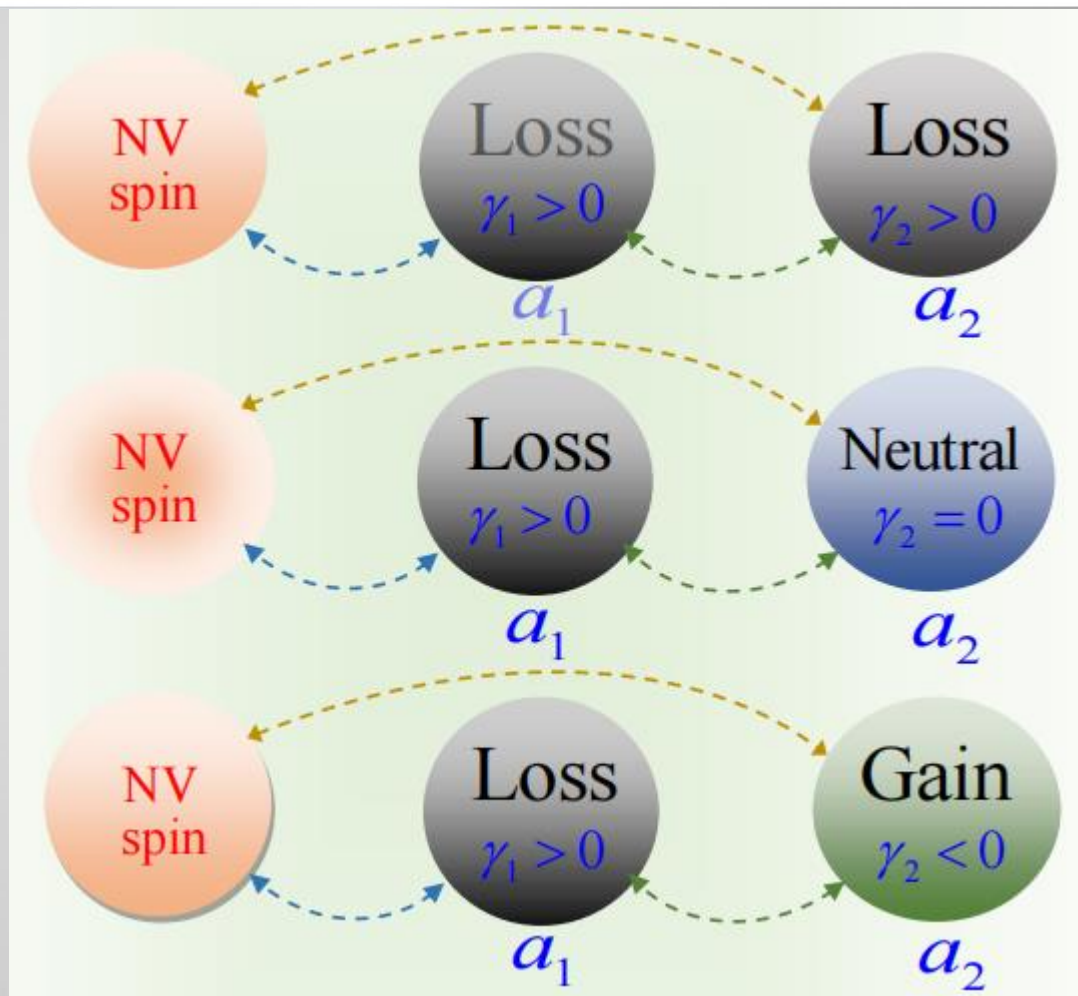

谢谢!

